



TELEDYNE HASTINGS INSTRUMENTS

HPM-2002-OBE

FEATURES

- Low-Cost Electronics Module
- Wide Dynamic Range (1×10^{-4} - 1000 Torr)
- Combined Sensors in a Single Tube
- Input Voltage (12-30 VDC)
- 15-pin High-Density D-sub Connector
- Bright 4-Digit (green) LED Display
- Optional Outputs
- Dual 0-10V
- RS232/485
- Dual 4-20 mA
- DeviceNet™

APPLICATIONS

- Loadlock
- Plasma Coating
- OEM Equipment
- Wide Range Vacuum Controls
- Refrigeration

HPM-2002-OBE



DESCRIPTION

The OBE is system-mounted gauge which provides the user with a low-cost method of accurate vacuum measurement over a wide range of pressure. The OBE uses the same rugged HPM-2002S tube as the award-winning Model 2002®. The module contains all of the performance features of the Model 2002 dual sensor instrument in a compact configuration. The OBE electronics module is available with many different types of signal output options for the user.

OBE is ideal for applications that require accuracy without the expense of costly capacitance manometers and a wide measurement range without multiple gauges.

The OBE can be configured to provide one of several different output options. These include Dual 0-10 VDC, RS232, RS485, Dual 4-20 mA, or DeviceNet™. All output options, except DeviceNet™, include a 4-digit LED display. The display provides floating-point pressure readout which is easily visible from several meters.

The 0-10 VDC analog output version generates two outputs which are linear with pressure. The first output has a 1024 Torr full scale value; the second output has a 1000 mTorr full scale value.

Specifications and Standards

DESIGN FEATURES (cont)

A digital communication version provides either RS232 or RS485 output to the user's PC. A simple set of commands allows the user to configure and read the OBE. The RS485 configuration is capable of communication up to 4000 feet with up to 31 addressable instruments on the same bus.

Often used in industrial equipment, the dual 4-20 mA option gives the user two linear current outputs. The first 4-20 mA channel spans the pressure range to 1024 Torr full scale. The second channel spans to 1000 mTorr full scale.

A DeviceNet™ compatible version completes the available options for this wide range vacuum instrument. The DeviceNet™ protocol is a simple communications link to connect many different types of industrial devices to a network using standard hardware. This standard allows easy interchangeability among line products. The HPM-2002-OBE with DeviceNet™ has been fully tested and has earned the "DeviceNet Conformance Tested Service Mark".

HPM-2002S Tube

The Model 2002 sensors are mounted in a rugged corrosive resistant 316 stainless steel tube. The small packaging reduces the transducer's internal volume, significantly improving response time. The tube can be mounted in any orientation with no effect on calibration and is far more rugged than standard fragile convection driven Pirani tubes.

The two sensors are packaged on a single gold plated Kovar header. This header is welded into the stainless steel tube shell and will withstand positive pressure to 150 psi.

Proof pressure is 30 psig, above this pressure permanent damage to sensors may occur.

Each HPM-2002S transducer contains a programmable memory chip (EEPROM). Stored on the EEPROM are the calibration parameters for both the thin film Pirani and the piezoresistive bridge.

Zeolite Filter

A Zeolite Filter accessory is available for protecting the sensor from contamination.

Performance

Measuring Range	1x10 ⁻⁴ to 10 ³ Torr
Ambient Temperature	
Operating Range & Compensation	0 to 50°C
Accuracy (Based on N ₂ @ 23°C)	± 1.5% of reading (1000 to 50 Torr) ± 20% of reading (50 to 1x10 ⁻³ Torr)
Output Options (choose one)	Dual (0-10 VDC linear), Dual (4-20 mA), RS232, RS485, DeviceNet™
Digital Readout	4-digit LED Floating Point
Input Voltage	12-30 VDC
Stability with Voltage Variation	Undetectable change in reading as input power fluctuates
Weight (approx.)	16 oz (W/KF-16 sensor)
Response Time	200 msec
Sensor Mounting	Any position without recalibration
Sensor Internal Volume	< 1.5 cc
Wetted Materials	Silicon Nitride, Silicon, Gold, Pyrex, 316 SS, UHV Epoxy
Calibrated for Nitrogen	Conversion curves for other gases are easily selectable
Burst Pressure (tube)	150 psig
Proof Pressure *	30 psig
* Maximum pressure above which may cause permanent damage	

Diagnostic Tube

The HPM-2002-DIAG allows users to verify proper operation of the HPM-2002 control unit and cabling. This diagnostic tube contains the same electronics as an HPM-2002S tube, however both sensors are replaced with known resistive loads. This allows a simulation of the voltage and power levels obtained in the crossover range of the two sensors, thereby causing the controller to indicate a pressure level of approximately 15 Torr. An EEPROM memory chip is also active within the diagnostic tube, allowing verification that the control unit can read the sensor's memory data. (Note: There is no calibration information stored in the control unit. All coefficients are stored in the individual sensor; therefore, the diagnostic tube cannot be used in any way as a calibration device.)

Hastings Instruments reserves the right to change or modify the design of its equipment without any obligation to provide notification of change or intent to change.

Outline Drawing

OBE ANALOG VERSION

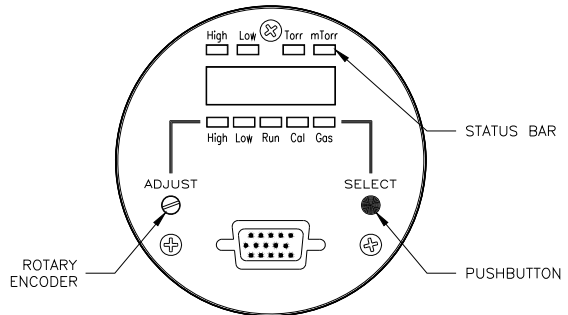

OBE RS232/485 VERSION

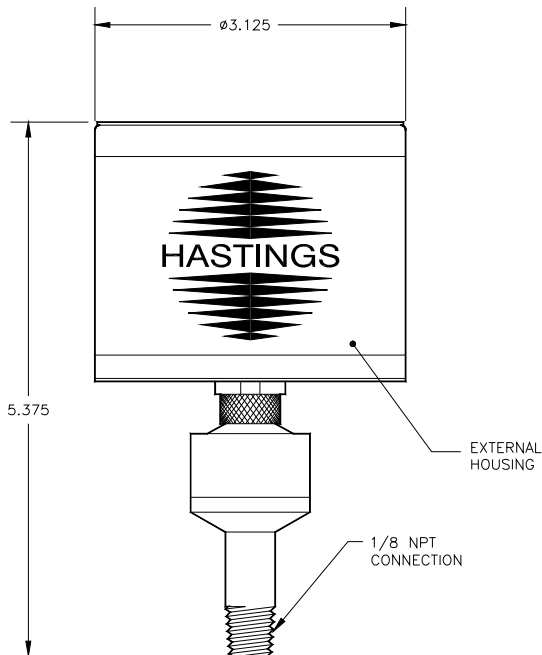
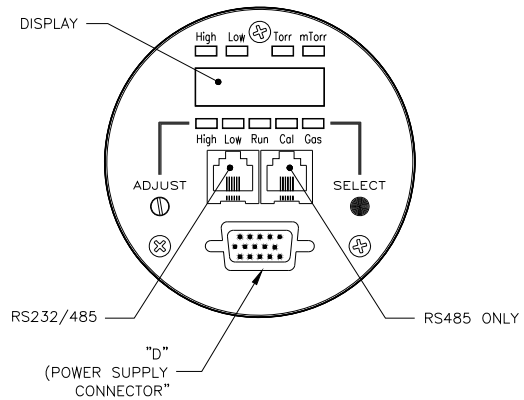

Outline Drawing

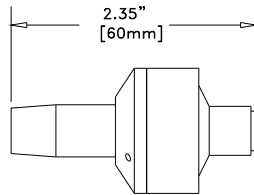
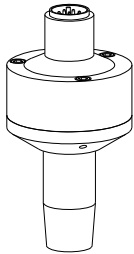

1/8" NPT (HPM-2002s-01)

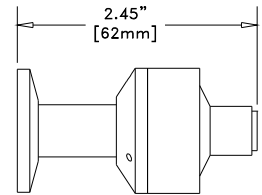
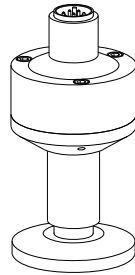

KF-16 (HPM-2002s-05)

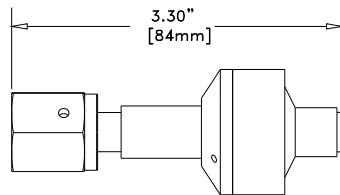
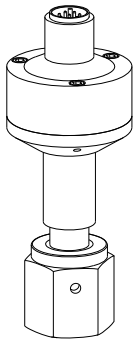

1/4" VCR (HPM-2002s-02)

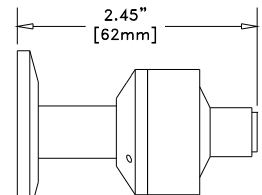
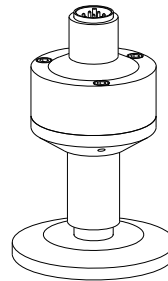

KF-25 (HPM-2002s-06)

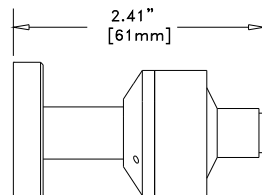
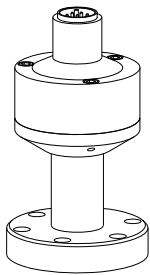

Mini Conflat™ (HPM-2002s-03)

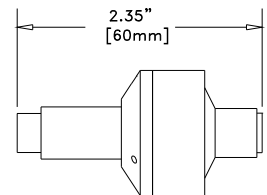
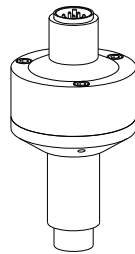

1/2" OD Smooth tube (HPM-2002s-07)

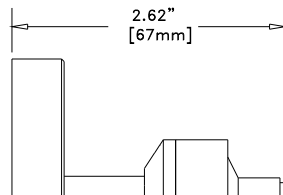
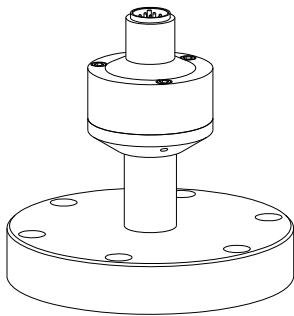

2-3/4" Conflat™ (HPM-2002s-04)

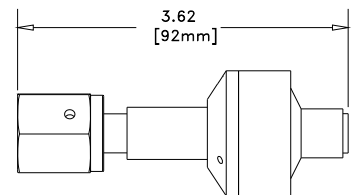
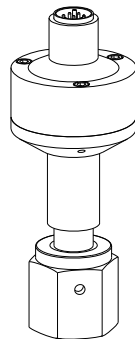

1/2" VCR (HPM-2002s-08)

Selection Chart

